

AVAILABLE IN 10" LENGTHS

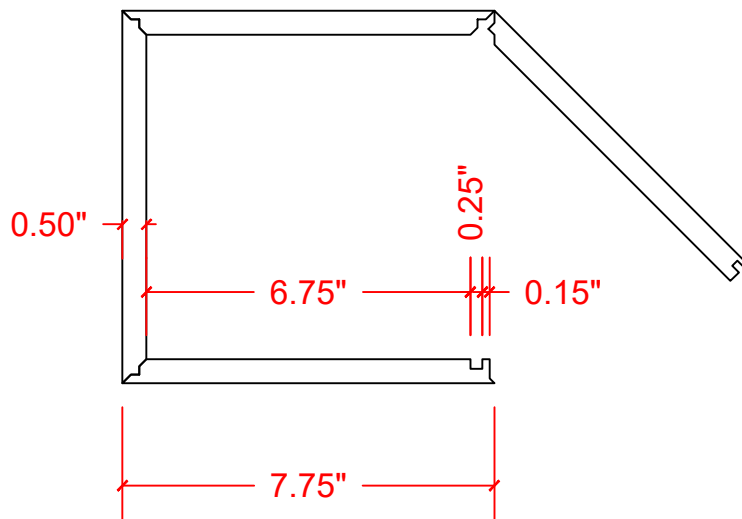

VERSATEX Building Products
www.versatex.com
724.857.1111

NOMINAL 6" X 6" VERSAWRAP
ACCENT WRAP

Scale: 3"=1' ACTUAL INSIDE
6-3/4" X 6-3/4"

Part No. VWAW060610